

**CP226**

---

**SMARTBUSINESS  
WALKIE TALKIE**

USER MANUAL

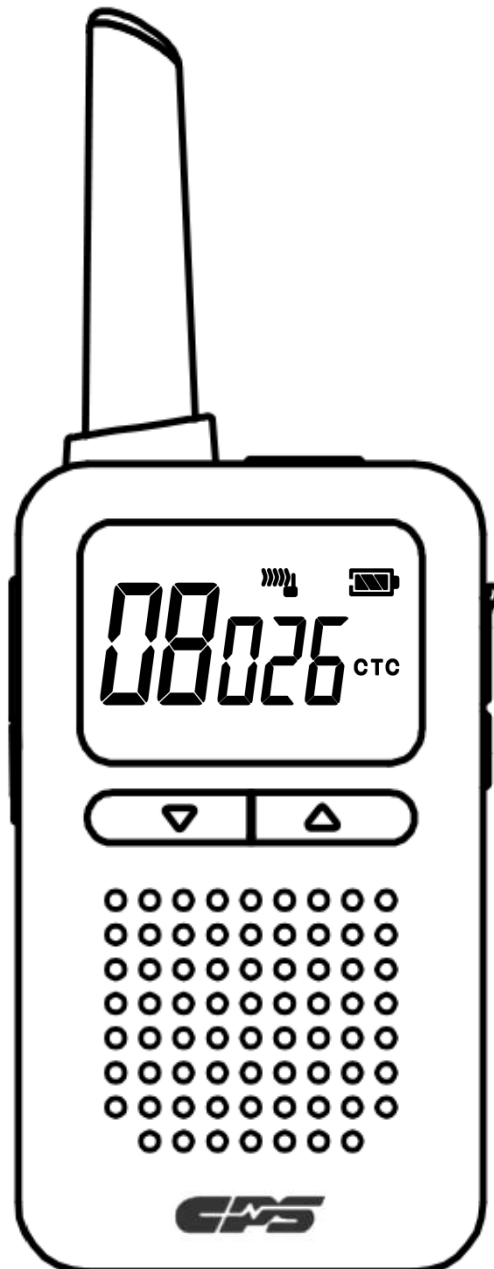

## 1. GENERAL INFORMATION

### 1.1 【Introduction】

The CP226 ARC mini Business Walkie Talkie combines quality and versatility with an elegant design that ensures effective communications right at your fingertips.

### 1.2 【Key Features】

- ✧ 53CTCSS and 104 DCS
- ✧ Volume setting (1–16)
- ✧ Key Lock
- ✧ Battery Saving
- ✧ 0.5Watt High Power Speaker Output
- ✧ 3.7V 1100mAh Li-Polymer Battery pack
- ✧ Channel Scan—Scans for activity across different communications channels
- ✧ RSSI—Receiving signal strength indication
- ✧ Battery Level Indicator
- ✧ Standby indicator
- ✧ Intelligent ear-microphone adjustment
- ✧ IP67 certified \* – protected from dust and waterproof  
(protected from immersion in water with a depth of 1 meter for up to 30 minutes)

### 1.3 【Accessories】

- ✧ CB28 Li-Polymer Battery pack
- ✧ Owner's manual

### 1.4 【Optional Accessories】

- ◆ EM28 Earbud microphone
- ◆ EM25 Ear-hook microphone
- ◆ EM22 Ear-tube microphone
- ◆ EM32 Earbud microphone
- ◆ CS20-26 Charging Stand with CWC20 Adaptor
- ◆ CS28-26 Rapid Charger (4 Slots)

## 2. CONTROLS AND INDICATORS

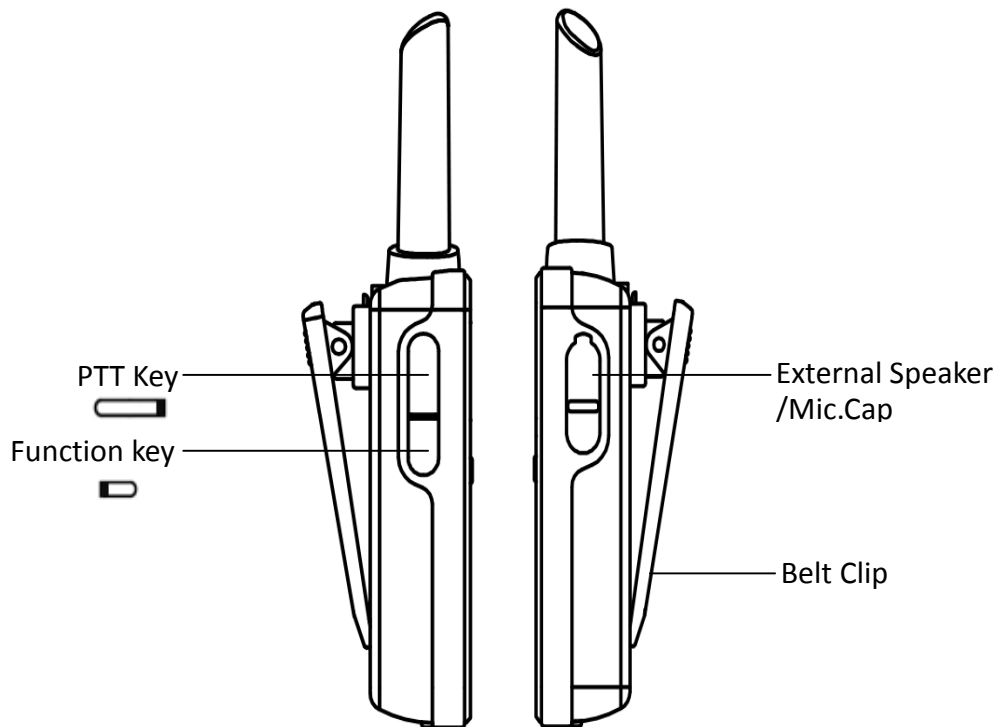
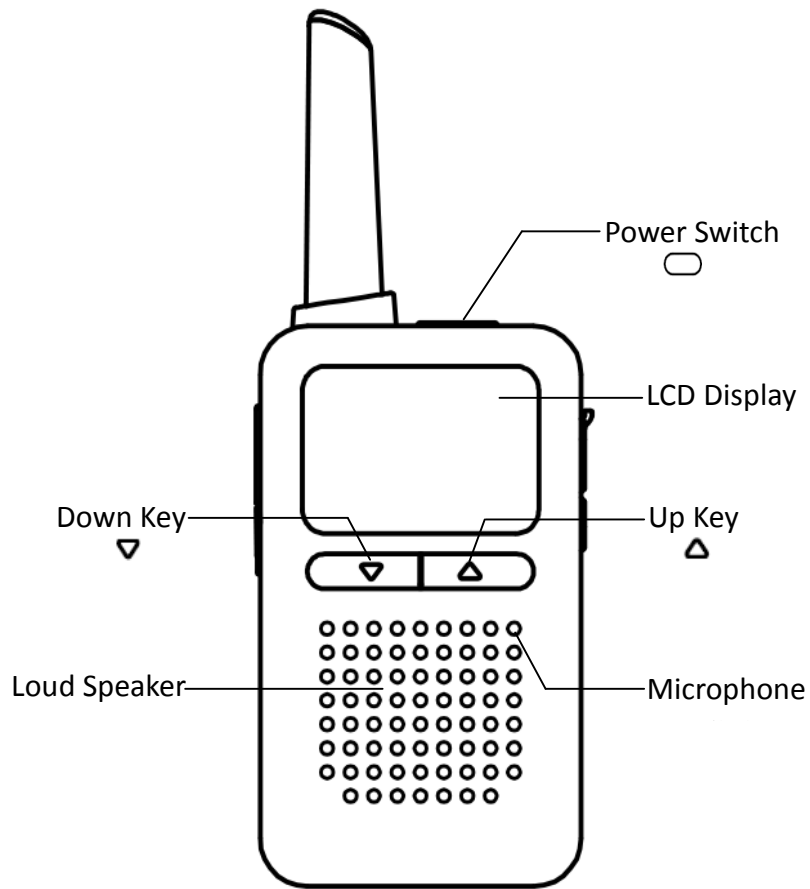

## 2. CONTROLS AND INDICATORS

ENGLISH

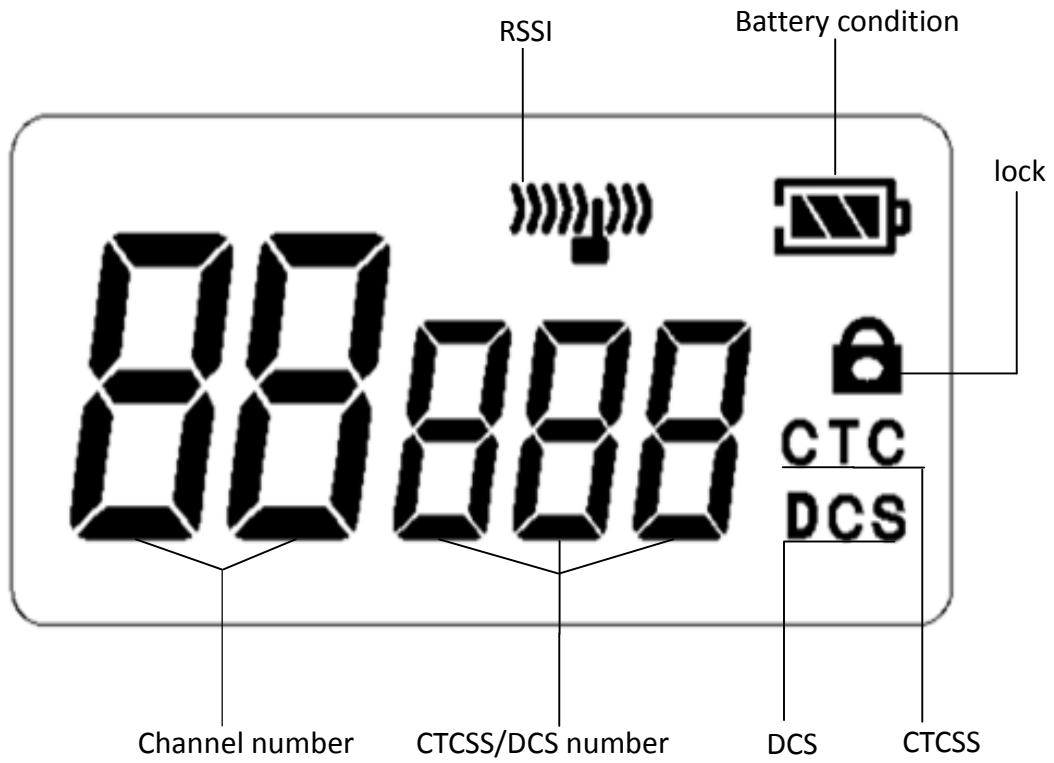

### 3. CHARGING THE BATTERY

#### 3.1 【Charging】

- 1) Plug the AC adaptor into a standard electrical outlet
- 2) Insert the Walkie Talkie into the charging tray for charging.

It will take 3 - 4 hours for full charging



### 4. MENU SETTING

#### 4.1 【Menu Setting】

Press [ ] key and [ ] key simultaneously to enter Menu mode, press [ ] key to choose desired menu and press [ ] key to select the function then press [ ] key to save it. If no operation, 10 seconds will automatically exit the menu setting.

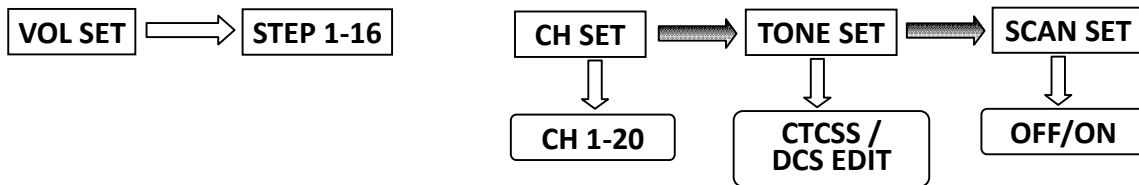

### 5. CHANNEL SETTING BRIEF NOTE

- Press and hold the [ ] key on the top of the unit.
- Press [ ] key and [ ] key simultaneously until the letter CH is blinking, press [ ] key to select the number of Channel.
- Press [ ] key and the screen will display CTC off , press [ ] key to select your desired CTCSS/DCS ( CTCSS 1 – 53, DCS 1 – 104 )
- Press [ ] key until “SC\*\*\*” is blinking, to select the scanning ON/OFF by pressing [ ] key and confirm it by pressing [ ] key. to cancel the scanning by pressing [ ] key.
- Press [ ] key to complete this setting or to press [ ] key again to have the other functions , press [ ] key to select number, you may press [ ] key at any time to complete this setting.
- Press [ ] key at the side and [ ] key simultaneously to LOCK /UNLOCK the unit, after Lock, the unit can only be allowed to adjust volume or transmit and receive.

## 6. OPERATION



### 6.1 【Power On / Off】

To turn the radio on or off, press and hold the power on (  ) key .

### 6.2 【Volume】

Adjust the volume level by using (  ) key (16 steps, default 8)

### 6.3 【Transmission】

Press and hold the (  ) key while speaking at about 5cm from the microphone for transmission. Release the (  ) key to return to standby mode.





### 6.4 【Reception】

Listen for activity on the selected channel.



### 6.5 【Key Lock】

Press (  ) key and (  ) key simultaneously to select Key Lock ON / OFF





### 6.6 【Channel Selection】

Press (  ) key and (  ) until “\*\* CH” is blinking, to select the channel number by pressing (  ) key and confirm it by pressing (  ) key . To select channel quickly, press and hold the (  ) key.

### 6.7 【CTCSS / DCS】

During setting, to press the (  ) key until “CTCSS / DCS\*\*\*” is blinking, to select the CTCSS /DCS number by pressing (  ) key and confirm it by pressing (  ) key.

### 6.8 【Scan】

During setting, to press the (  ) key until “SC\*\*\*” is blinking, to select the scanning ON/OFF by pressing (  ) key and confirm it by pressing (  ) key. to cancel the scanning by pressing (  ) key.

### 6.9 【Intelligent ear-mic adjustment】

When plug in ear microphone, the device will automatically reset the volume to comfort level ( originally set by factory or by user whichever the lower )

## 1. 概述

### 1.1 【概述】

CP226 ARC mini 商用對講機結合了高品質和多功能性以及優美輕巧的設計，確保有效的通信令您得心應手。

### 1.2 【功能描述】

- ◇ 內置 53 個單音 CTCSS 及 104 個 DCS 數字私線組合 DCS(CTCSS 及 DCS)
- ◇ 音量調較(16 級)
- ◇ 鍵盤鎖功能
- ◇ 省電功能
- ◇ 0.5W 音頻功率輸出
- ◇ 3.7V 1100mAh 鋰高分子電池
- ◇ 頻道掃描
- ◇ 接收訊號強弱顯示(RSSI)
- ◇ 電量狀態顯示
- ◇ 待機提示
- ◇ 智能耳機調較
- ◇ IP67 認證\* -防塵和防水（浸入水中深度 1 米，長達 30 分鐘）

### 1.3 【配件】

- ◇ CB28 鋰高分子電池
- ◇ 說明書

### 1.4 【另購配件】

- ◆ EM28 耳塞麥克風
- ◆ EM25 耳掛式麥克風
- ◆ EM22 耳管式麥克風
- ◆ EM32 耳塞麥克風
- ◆ CS20-26 充電座連 CWC20 火牛
- ◆ CS28-26 四位快速充電座

## 2. 控制鍵及顯示說明

CHINESE

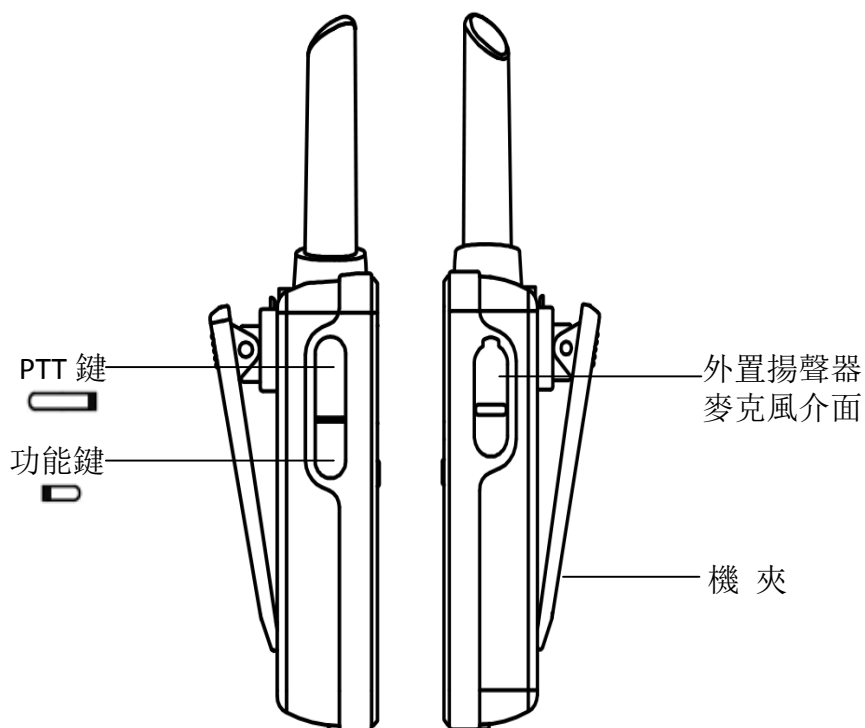
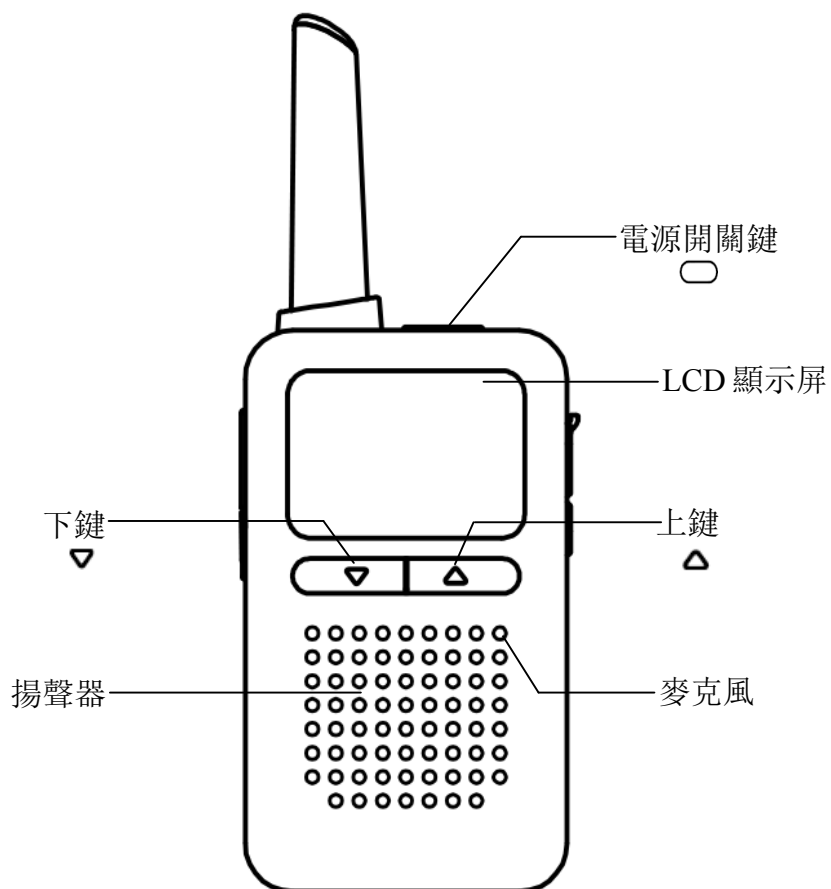



## 2. 控制鍵及顯示說明



### 3. 充電

#### 3.1 【充電】

- 1) 將 DC 插頭插入充電座並將電源適配器接入 AC 電源
- 2) 對講機放入充電座進行充電，充電時間: 3-4 小時



### 4. 功能選擇

#### 4.1 【功能選擇】

同時按下 ( ) 鍵及 ( ) 鍵可進入功能選擇，繼續按下 ( ) 鍵可進入所需功能選擇,然後按 ( ) 鍵選擇所需功能，按下機側 ( ) 鍵確認。若無按鍵操作，10 秒後將自動退出選單畫面。

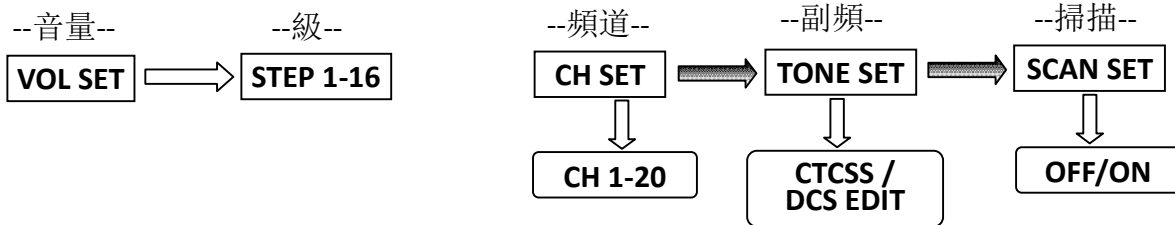

### 5. 簡易調頻方法



- 先在機頂長按 ( ) 鍵開機。
- 同時按下 ( ) 鍵及 ( ) 鍵,直至 LCD 屏幕數字閃動，再按 ( ) 鍵揀選通話頻道。
- 再輕按 ( ) 鍵， LCD 屏幕會出現 CTC OFF， 再按 ( ) 鍵揀選副頻道 (CTCSS 1-53,DCS 1-104) 。
- 再輕按 ( ) 鍵進入“SC \*\*\*”掃描設置模式，按 ( ) 鍵可選擇開或關，然後按下 ( ) 鍵確認；或按下 ( ) 鍵退出掃描。
- 此時可按下機側 ( ) 鍵完成調頻或可再按 ( ) 鍵跳至以下顯示並以 ( ) 鍵揀選需要的設定，任何時候皆可按下機側 ( ) 鍵完成設定。
- 將機側 ( ) 鍵與 ( ) 鍵同時按下，可以把該機上鎖或開鎖,當上鎖後，此機祇可以調較音量及對講。

## 6. 一般操作



### 6.1 【開機/關機】

持續按下電源〔〕鍵開機或關機。

### 6.2 【音量調較】

按〔|〕鍵調較音量(共有 16 級, 出廠預設為 8 級)。

### 6.3 【發射】

持續按下機側〔〕鍵對距離麥克風 5cm 講話, 鬆開機側〔〕鍵恢復接收狀態。







### 6.4 【接收】

對講機處於待機模式, 以便接收訊號。





### 6.5 【鍵盤鎖】

同時按下〔〕鍵及〔〕鍵可選擇開或關鍵盤鎖。





### 6.6 【頻道選擇】

同時按下〔〕鍵及〔〕進入“\*\* CH”頻道選擇模式, 頻道號碼將會閃動, 按〔|〕鍵選擇所需頻道, 再按〔〕鍵確認。當持續按〔|〕鍵時, 頻道會不停地調上/調下。

### 6.7 【CTCSS / DCS 模擬亞音頻/數字亞音頻設置】

於調頻時, 按下〔〕鍵進入“CTC/DCS\*\*\*”模擬亞音頻/數字亞音頻設置模式, 按〔|〕鍵選擇所需副頻, 然後按下〔〕鍵確認 (如開啟此功能, 收發雙方需選用相同的頻道、CTCSS / DCS 代碼才能互相通話)。

### 6.8 【掃描】

於調頻時, 按下〔〕鍵進入“SC \*\*\*”掃描設置模式, 按〔|〕鍵可選擇開或關, 然後按下〔〕鍵確認; 或按下〔〕鍵退出掃描。

### 6.9 【智能耳機調較功能】

當插入耳機時, 將自動調較之合適音量 (以出廠值或用戶自選之最低值為標準)

## TECHNICAL SPECIFICATIONS

<b>General</b>			
Battery type		Li-Polymer	
Battery capacity		1100mAh	
Temperature range		20°C-+55°C	
Frequency stability		±2.5ppm	
Size (HxWxD)		74x44x19mm	
Weight Incl. battery		75g	
Sub tones		CTCSS/DCS	
CP226A	Ausralia	Frequency range	476.425 –477.4125 MHz
		Channels	80 CHs
CP226B	British Malaysia Singapore	Frequency range	446.00625– 446.09375MHz
		Channels	8 CHs
CP226C	China	Frequency range	409.7500 – 409.9875MHz
		Channels	20 CHs
CP226E	E U	Frequency range	446.00625–446.09375MHz
		Channels	8 CHs
CP226H	Hong Kong, Macau	Frequency range	409.7500 – 409.9875MHz
		Channels	20 CHs
CP226J	Japan	Frequency range	422.05 – 422.30 MHz
		Channels	20 CHs
		Frequency range	Tx 440.025 – 440.3625 MHz Rx 421.575 – 421.9125 MHz
		Channels	27 CHs
CP226K	Korea	Frequency range	448.750 – 449.2625MHz
		Channels	25 CHs
CP226T	Taiwan	Frequency range	467.5125 – 467.6750MHz
		Channels	14 CHs
CP226R	Russia	Frequency range	433.07500–434.77500MHz
		Channels	69 CHs
		Frequency range	446.00625–446.09375MHz
		Channels	8 CHs
CP226U	USA	Frequency range	462.5500 – 467.7125MHz
		Channels	22 CHs

※※ Features & Specifications are subject to change without notice

**CTCSS**

<b>CH</b>	<b>Frequency</b>	<b>CH</b>	<b>Frequency</b>	<b>CH</b>	<b>Frequency</b>	<b>CH</b>	<b>Frequency</b>
1	67.0	14	107.2	27	167.9	40	159.8
2	71.9	15	110.9	28	173.8	41	183.5
3	74.4	16	114.8	29	179.9	42	189.9
4	77.0	17	118.8	30	186.2	43	196.6
5	79.7	18	123.0	31	192.8	44	199.5
6	82.5	19	127.3	32	203.5	45	206.5
7	85.4	20	131.8	33	210.7	46	229.1
8	88.5	21	136.5	34	218.1	47	254.1
9	91.5	22	141.3	35	225.7	48	165.5
10	94.8	23	146.2	36	233.6	49	171.3
11	97.4	24	151.4	37	241.8	50	177.3
12	100.0	25	156.7	38	250.3	51	60.7
13	103.5	26	162.2	39	69.3	52	62.5
						53	64.7

**DCS**

<b>CH</b>	<b>DCS Code</b>	<b>CH</b>	<b>DCS Code</b>	<b>CH</b>	<b>DCS Code</b>	<b>CH</b>	<b>DCS Code</b>
1	023	28	172	55	431	82	743
2	025	29	174	56	432	83	754
3	026	30	205	57	445	84	036
4	031	31	223	58	464	85	053
5	032	32	226	59	465	86	122
6	043	33	243	60	466	87	145
7	047	34	244	61	503	88	212
8	051	35	245	62	506	89	225
9	054	36	251	63	516	90	246
10	065	37	261	64	532	91	252
11	071	38	263	65	546	92	255
12	072	39	265	66	565	93	266
13	073	40	271	67	606	94	274
14	074	41	306	68	612	95	325
15	114	42	311	69	624	96	332
16	115	43	315	70	627	97	356
17	116	44	331	71	631	98	446
18	125	45	343	72	632	99	452
19	131	46	346	73	654	100	454
20	132	47	351	74	662	101	455
21	134	48	364	75	664	102	462
22	143	49	365	76	703	103	523
23	152	50	371	77	712	104	526
24	155	51	411	78	723		
25	156	52	412	79	731		
26	162	53	413	80	732		
27	165	54	423	81	734		

## ■ WARRANTY

CPS Telecom will give 12 months warranty against failure made by the manufacturer from the date of purchase. The warranty will not cover damage made by the user, the user opening the equipment, moist, dirt, heat or cold. The warranty will not cover lightning/overvoltage.

Please contact your dealer if a problem with the equipment arises.

## ■ WASTE DISPOSAL

Electrical and electronic products can contain materials, parts and units that can be dangerous for the environment and human health. Products marked with the WEEE mark (shown below), shall not be disposed together with your normal household waste. Please inform yourself about the local rules and disposal collection system for electrical and electronic products. The correct disposal of your old product will help to prevent negative consequences for the environment and human health.

(WEEE = Waste of Electrical & Electronic Equipment).



**CPS Telecom Limited**

[www.cps-telecom.com](http://www.cps-telecom.com)

[cs@cps-telecom.com](mailto:cs@cps-telecom.com)



[http:// www.cps-telecom.com](http://www.cps-telecom.com)

 is the registered trademark of CPS Telecom Limited, Hong Kong  
© 2018 CPS Telecom Limited CPS20180118226V.1.2